

Technical specifications

CLF160-T (T-piece CLF160)

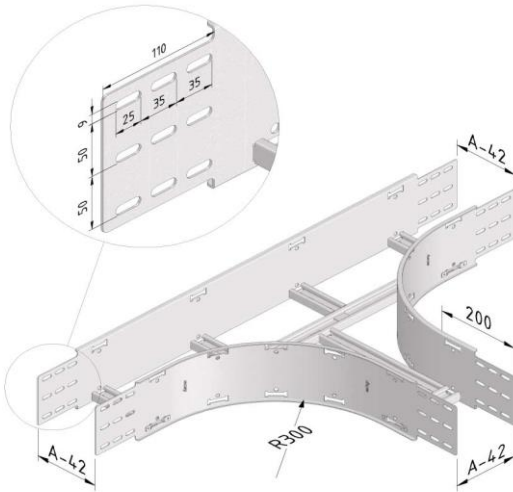

Finishing:		Ultra galva						
Product	Number	Height (mm)	Width (mm)	Length (mm)	Dim A (mm)	Fmax (kN)	Unit	Packaging (unit)
CLF160-T-0200-UG	17696	160	200	0	200		ST	1
CLF160-T-0300-UG	17697	160	300	0	300		ST	1
CLF160-T-0400-UG	17698	160	400	0	400		ST	1
CLF160-T-0500-UG	17699	160	500	0	500		ST	1
CLF160-T-0600-UG	17700	160	600	0	600		ST	1

Finishing:		Duplex						
Product	Number	Height (mm)	Width (mm)	Length (mm)	Dim A (mm)	Fmax (kN)	Unit	Packaging (unit)
CLF160-T-0200-DU	18021	160	200	0	200		ST	1
CLF160-T-0300-DU	18022	160	300	0	300		ST	1
CLF160-T-0400-DU	18023	160	400	0	400		ST	1
CLF160-T-0500-DU	18024	160	500	0	500		ST	1
CLF160-T-0600-DU	18025	160	600	0	600		ST	1

Mounting instructions:

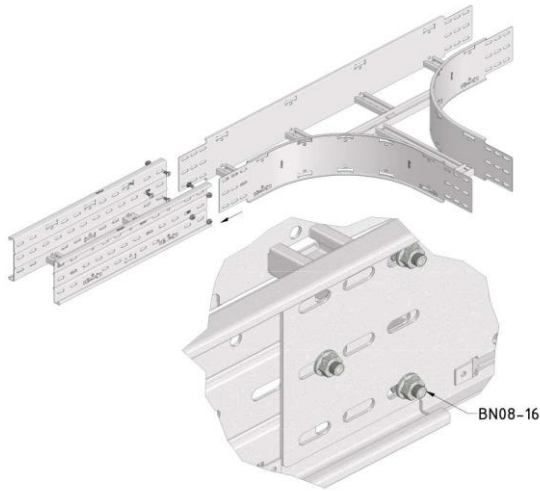

Load capacity:

Standard:	-
Max. load:	-
Load diagram:	-

Information:

Coupler:	BN08-16
Equipotential bonding:	IEC61537
EC declaration:	EC directive 2014/35/EU (Low voltage) as modified by directive 93/68/EEC (CE marking)

UG

ULTRA GALVA (UG)

is a high-performant metallic coating which offers an optimum surface protection in a wide variety of aggressive and demanding environments, indoor as well as outdoor. The unique alloy of small amounts of magnesium and/or aluminium in the zinc bath provides ULTRA protection with a self-healing effect. Whilst zinc is essential for cathodic protection, magnesium prevents red rust. The passivation layer that comes on top, creates a seal that slows down the first traces of white rust.

ULTRA GALVA offers a number of advantages compared to the traditional hot dip finishing.

- the passivation layer offers a superior protection level. Hence, ULTRA GALVA, being cathodical, is self-healing in case of scratches, edges or perforations. Compared to hot dip, the articles remain very straight, no deflections appear nor flux or dull spots/ashes.
- ULTRA GALVA can conveniently be cold-processed without any risk on flakes because of the perfect adhesion of the coating to the metal.
- No zinc pins appear which enables one to install cables in a fast way avoiding any risk on damages to cables nor injuries of workers.
- Thanks to the longer life span, ULTRA GALVA does not require ongoing maintenance nor post painting actions.
- Three times less zinc is being applied compared to hot dip finishing. There is hence a lower impact on natural resources as well as less pollution. On top, its production process generates less CO2 emission and ULTRA GALVA is 100% recyclable.

ULTRA GALVA is hence a very valuable environmentally friendly alternative for the traditional stainless steel and hot-dip finishing !

DU

Duplex coats DU

For applications where a very high corrosion resistance is required, such as the petrochemical industry or maritime applications, we advise our customers to use a duplex coating. A duplex coating is composed of a hot-dip galvanizing, followed by a powder coating (in two coats or one). Research has showed that galvanized parts with an (epoxy) powder coating, afford corrosion resistance that is up to 2.5 times higher than the sum of the wear life of both systems separately.

For example: the wear life of hot-dip galvanizing is 10 years while that of an epoxy coating is 5 years. So, in combination, this gives a wear life of up to 37 years. Usually, the added cost of a duplex coating is easily outweighed by the cost price of regularly recurring maintenance every few years. (see underneath 'hot-dip galvanizing').

Field of application according to resistance against corrosion:

Corrosion classes according EN ISO 12994

Corrosion class	Atmospheric corrosion	Indoor environment	Outdoor environment	Surface treatments
C1	< 0,1µm	Heated buildings with neutral atmospheres: offices, shops, schools, hotels.		Electro-galvanised (EG) EN ISO 2081
C2	0,1 - 0,7µm	Unheated buildings where condensation may occur: sports halls, warehouses, shops.	Rural areas. Atmosphere with low impurities.	Pre-galvanised (PG) EN 10327 – EN 10143
C3	0,7 - 2µm	Production facilities with high moisture levels and some air impurities due to industrial processes: production plants.	City and industrial atmosphere, some impurities, coastal areas with low salt loads.	Dipped-galvanised (DG) EN ISO 1461
C4	2 - 4µm	Production facilities with high moisture levels and high air impurities due to industrial processes: swimming pools, Chemical industry.	Industrial areas and coastal areas with low salt load.	Dipped-galvanised (DG) EN ISO 1461 Polyester coating (CO) EN ISO 12944
C5-I	4 - 8µm	Polyester coating (CO)	Industrial areas with high moisture level and aggressive atmosphere.	Duplex (DU) (Dipped galvanised + Polyester coating) Stainless steel AISI 316L
C5-M	4 - 8µm	EN ISO 12944	Coastal or offshore areas with salt load.	Duplex (DU) (Dipped galvanised + Polyester coating)

Classification for resistance against corrosion according to IEC61537

Class	Reference- Material and Finish
0(a)	None
1	Electroplated to a minimum thickness of 5 µm
2	Electroplated to a minimum thickness of 12 µm
3	Pre-galvanised to grade 275 to EN 10327 and EN 10326
4	Pre-galvanised to grade 350 to EN 10327 and EN 10326
5	Post-galvanised to a zinc mean coating thickness (minimum) of 45 µm according to ISO 1461 for zinc thickness only
6	Post-galvanised to a zinc mean coating thickness (minimum) of 55 µm according to ISO 1461 for zinc thickness only
7	Post-galvanised to a zinc mean coating thickness (minimum) of 70 µm according to ISO 1461 for zinc thickness only
8	Post-galvanised to a zinc mean coating thickness (minimum) of 85 µm according to ISO 1461 for zinc thickness only (usually high silicon steel)
9A	Stainless steel manufactured to ASTM: A 240/A 240M – 95a designation S30400 or EN 10088 grade 1-4301 without a post-treatment (b)
9B	Stainless steel manufactured to ASTM: A 240/A 240M – 95a designation S31603 or EN 10088 grade 1-4404 without a post-treatment (b)
9C	Stainless steel manufactured to ASTM: A 240/A 240M – 95a designation S30400 or EN 10088 grade 1-4301 with a post-treatment (b)
9D	Stainless steel manufactured to ASTM: A 240/A 240M – 95a designation S31603 or EN 10088 grade 1-4404 with a post-treatment (b)
(a) For materials which have no declared corrosion resistance classification.	
(b) The post-treatment process is used to improve the protection against crevice crack corrosion and the contamination by other steels.	